

# INSTRUCTION MANUAL

## FOR DIESEL ENGINE-DRIVEN AC GENERATING SET

MODEL : DCA-800SPK

**По вопросам продаж и поддержки обращайтесь:**

Архангельск (8182)63-90-72  
Астана +7(7172)727-132  
Астрахань (8512)99-46-04  
Барнаул (3852)73-04-60  
Белгород (4722)40-23-64  
Брянск (4832)59-03-52  
Владивосток (423)249-28-31  
Волгоград (844)278-03-48  
Вологда (8172)26-41-59  
Воронеж (473)204-51-73  
Екатеринбург (343)384-55-89  
Иваново (4932)77-34-06  
Ижевск (3412)26-03-58  
Иркутск (395) 279-98-46  
Киргизия (996)312-96-26-47

Казань (843)206-01-48  
Калининград (4012)72-03-81  
Калуга (4842)92-23-67  
Кемерово (3842)65-04-62  
Киров (8332)68-02-04  
Краснодар (861)203-40-90  
Красноярск (391)204-63-61  
Курск (4712)77-13-04  
Липецк (4742)52-20-81  
Магнитогорск (3519)55-03-13  
Москва (495)268-04-70  
Мурманск (8152)59-64-93  
Набережные Челны (8552)20-53-41  
Нижний Новгород (831)429-08-12  
Казахстан (772)734-952-31

Новокузнецк (3843)20-46-81  
Новосибирск (383)227-86-73  
Омск (3812)21-46-40  
Орел (4862)44-53-42  
Оренбург (3532)37-68-04  
Пенза (8412)22-31-16  
Пермь (342)205-81-47  
Ростов-на-Дону (863)308-18-15  
Рязань (4912)46-61-64  
Самара (846)206-03-16  
Санкт-Петербург (812)309-46-40  
Саратов (845)249-38-78  
Севастополь (8692)22-31-93  
Симферополь (3652)67-13-56  
Таджикистан (992)427-82-92-69

Смоленск (4812)29-41-54  
Сочи (862)225-72-31  
Ставрополь (8652)20-65-13  
Сургут (3462)77-98-35  
Тверь (4822)63-31-35  
Томск (3822)98-41-53  
Тула (4872)74-02-29  
Тюмень (3452)66-21-18  
Ульяновск (8422)24-23-59  
Уфа (347)229-48-12  
Хабаровск (4212)92-98-04  
Челябинск (351)202-03-61  
Череповец (8202)49-02-64  
Ярославль (4852)69-52-93

Эл. почта: [dne@nt-rt.ru](mailto:dne@nt-rt.ru) || Сайт: <https://denyo.nt-rt.ru/>

This instruction manual gives a detailed description of the operation, routine inspection, maintenance, and troubleshooting of the generator, and other items required for proper operation. We therefore recommend that all users read this manual carefully before actually operating the generator to ensure proper operation.

For detailed operation, disassembly, reassembly and repair of the engine, please refer to the "Engine Instruction Manual" supplied by the engine manufacture.

## CONTENTS

1. PRECAUTIONS FOR SAFE OPERATION	1
2. SPECIFICATIONS	5
3. PARTS DESIGNATION	6
4. PREPARATION FOR OPERATION	15
5. OPERATION	22
6. PARALLEL OPERATION	26
7. STORAGE	28
8. INSPECTION AND MAINTENANCE	29
9. TROUBLESHOOTING	30
10. OUTLINE DRAWING	31
11. CONTROL AND OPERATING PANEL	32
12. GENERATOR CONNECTION DIAGRAM	33
13. SEQUENCE DIAGRAM	34
14. ENGINE CONNECTION DIAGRAM	35
15. SAFETY PRECAUTIONS FOR DIESEL GENERATING SETS AND EQUIPMENT	36

## 1 . PRECAUTIONS FOR SAFE OPERATION

This machine is designed with highest consideration to safety. Safest and most efficient operation, however, can be attained by paying attention to the following items.

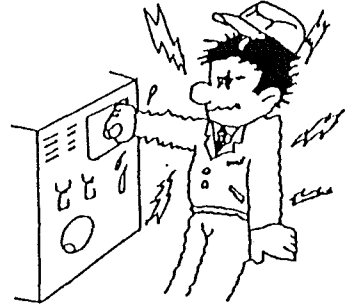

### (1) Operate Properly

Operate the machine properly according to the Instruction Manual to ensure safety.

Give proper guidance in operation

In allowing other personnel to use the machine, be sure to give them proper guidance in its operation and advise them to read the "Instruction Manual" before actually operating it.

### (2) Keep Free From Moisture

The operation of the machine in a place exposed to rain, moisture or wetness may cause electrocution. For operation under such conditions, be sure to ground the machine and the load side.

### (3) Housekeeping, The First Step

Do not place any unnecessary items around the machine. When the machine is to be located on an uneven or soft surface, install it horizontally so that it will not tilt during operation.

### (4) Clean Carefully And Frequently

The machine must be treated properly as your business partner. Note that the insulation of the generator may deteriorate depending on the place where it is used. If it is to be used in a place where dust and moisture are excessive, be sure to clean and dry it periodically.

(5) Pay Attention To Sufficient Ventilation

The exhaust gas discharged from the machine contains hazardous substances. When the machine is to be used in such a place as a tunnel, ventilate the place thoroughly during operation. When it is to be operated on the road, take care that the exhaust is away from pedestrians, nearby buildings, etc.

(6) Shut Down Operation Immediately If Any Abnormality Occurs

If the machine is found to operate improperly, or produce any abnormal odor, noise, or vibration, immediately shut down the operation for troubleshooting to correct the abnormality.

(7) Maintain Electrical Instrument Cables Properly

Damaged cables of the electrical instruments are very dangerous, causing electrocution and leakage. Therefore, if such a cable is found, immediately repair or replace it.

(8) Avoid Overloading

The generator is provided with a breaker for overload protection, which is actuated when it is overloaded. When the breaker has been actuated, reduce the load before restarting the machine.



(9) Never Touch The Output Terminal

Never touch the output terminal during the operation. Be sure to shut down the operation before touching the terminal for wiring, etc.

(10) Pay Attention To Storage And Transportation

During Inclement Weather

The machine is designed for dripproofing, but not for rainproofing. When it is to be stored or transported on an inclement day, take care to cover it.



(11) Wash The Machine Carefully

Wash the machine taking care that the control panel and the inlet and outlet ports are not exposed to water to prevent possible failure of the internal instruments.

(12) Take Precautions Against Fire

Handle fuel, oils and antifreeze (undiluted) with care because they are dangerous materials with high flammability. Do not bring any naked light such as lit tobacco or a burning match close to them. In addition, do not install and store the machine in a place near where fire is used.

(13) Connect Securely

Damaged cables and loosened screws result in machine failure and electrocution. Therefore, immediately repair such cables and tighten such screws securely, if any.

(14) Perform Inspection And Maintenance Work Perfectly

Keep the machine clean and its inside free from dust and moisture. In addition, perform its inspection and maintenance perfectly in accordance with the "Instruction Manual".



## 2. SPECIFICATION

### 2-1 AC Generator

Generator model	DF-8800
Type	Rotating-field, protection type (JP20) synchronous generator
Excitation	Brushless type (with AVR)
Continuous duty rating	700 / 800 KVA
Voltage	200 / 220 V or (380) {415} 400 / 440 V
Current	2021 / 2100 A or (1063){974}1010 / 1050 A
Frequency	50 / 60 Hz
Speed	1500 / 1800 rpm
Power factor	0.8 (lagging)
Phase	3 (4 wires)
Winding connection	Star
Insulation	Armature-winding -- F class Field-winding -- F class
Cooling system	Self-ventilation

### 2-2 Diesel Engine

Maker and model	KOMATSU LTD. SA12V140
	4 cycle, water cooled diesel engine, direct injection, turbocharged with aftercooler.
Rated output	834 / 1000 ps, 1500 / 1800 rpm
No. of cylinders	12
Bore × Stroke	140mm × 165mm
Displacement	30480 cc
Direction of rotation	Clockwise (viewed from the fan side)
Governor	Electronic governor
Cooling system	Water cooling by radiator with fan
Lubricating system	Gear pump
Starting motor	24 V - 7.5 kW × 2
Charging generator	24 V - 25 A
Battery	12 V - 200AH × 4
Fuel	Diesel fuel (JIS No.2 or equivalent)
Fuel tank	Approx. 490 l
Lubricating oil	API service class (CD class or higher)

### 3. PARTS DESIGNATION

#### 3-1. Description of Devices

##### (1) Starter Switch

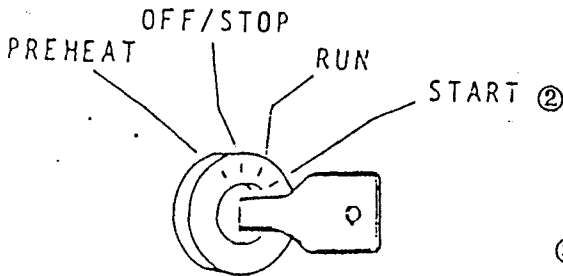

##### ① STOP

Keep the switch at this position except during operation.

This position allows the key to be inserted into and removed from the switch.

##### ② RUN

Keep the switch standing at this position during operation.

##### ③ START

Turn the switch to this position for start-up. When the key is released after startup, it automatically returns to "RUN" position.

- ④ For startup at low air temperature, set the switch at this position until the "PREHEAT" lamp becomes red-heated just before turning the key to "START" position.

##### (2) Tachometer

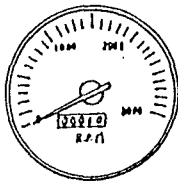

The tachometer indicates engine revolutions per minute. Set the engine speed so that the meter indicates 1500rpm at 50Hz and 1800rpm at 60Hz. The tachometer has a built-in integrating hour meter.

The integrating hour meter has been set for use at 1500rpm. Accordingly, when the meter is used at 1800rpm, it indicates an integrated hour value approximately 20% more than the actual operation time.

(3) Cooling Water Temperature Gauge

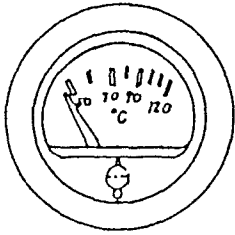

If machine is in normal operation, the indicator should be between 75 - 95 °C. If it indicates temperature above this range, turn off the load and turn the speed-change over switch to "LOW" position for cold operation to reduce the cooling water temperature.

(4) Lubricating Oil Pressure Gauge

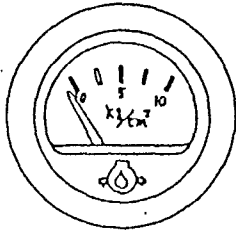

If the machine is in normal operation, the pressure gauge indicates 3~5 kg/cm². When the engine is cold, the pressure may rise above this range just after startup. In such cases, perform warming-up until the normal pressure is attained.

(5) Lubricating Oil Temperature Gauge

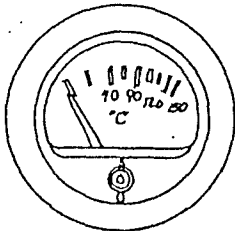

Indicates the oil temperature of the engine oil. The temperature of 100 °C or less is recommended.

(6) Fuel Level Gauge



Indicates the fuel level in the fuel tank.

(7) Charging Ampere Meter

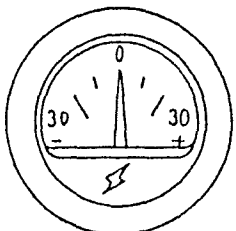

If the machine is in normal operation, the meter points to 0 or + range values (indicating its charged state).



(8) Preheat Lamp

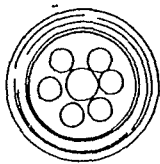

This lamp, when the key switch is turned to "PREHEAT" position, goes red-heated in about 30 seconds, indicating that the machine has been preheated.

(9) Dust Indicator

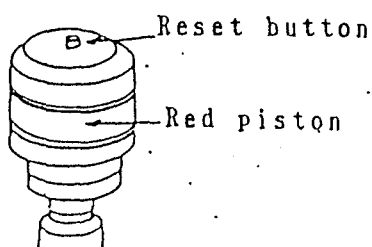

When the air cleaner element is clogged, the dust indicator's red piston sticks out of its transparent portion.

In such cases, immediately replace or clean the element. After replacement or cleaning, press the indicator button to return the red piston to its original position.

(10) Throttle Lever

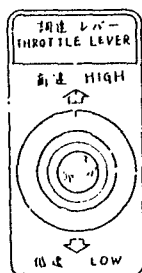

Turn the handle toward the "HIGH" side to increase the speed and toward the "LOW" side to decrease it.

(11) Battery Switch

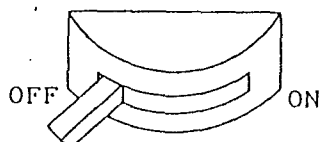

During operation, never turn the switch to "OFF" position, keeping it at "on".

If the engine is shut down, be sure to place the switch in "OFF" position.

(12) Speed Changeover Switch

① AUTO.IDLING

When the engine is started with the "SPEED" changeover switch set at this position, the engine idles for about 20 seconds and then automatically changes over to high-speed operation. When starting the engine, set the switch in this position.

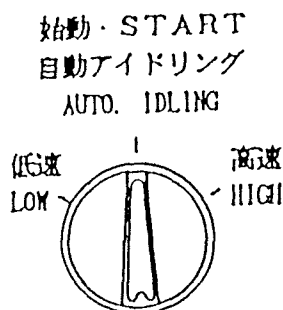

② LOW

When the switch is turned to this position, the engine continues to idle.

③ HIGH

Turning the switch to this position releases the "automatic idling" function, allowing the engine to be run at the speed set by the throttle handle.

(13) Running Caution Lamp

This lamp goes on during low-speed operation.

(14) Emergency Stop Button

This is a pushbutton to stop the engine urgently on emergency case.

Do not push the button without emergency case.

(15) Oil Filter Alarm Lamp

This lamp will go on when the oil filter is blinded. If the lamp lights up, replace the filter element immediately.

(16) OK Monitor

This monitor indicates the following failures, if any one of them occurs.

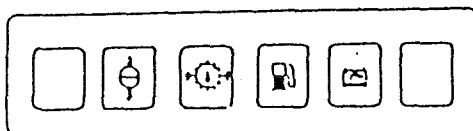

① Overheat



This lamp goes on when the cooling water temperature rises abnormally. If the lamp goes on during operation, the emergency stop device immediately operates to shut down the engine automatically.

② Oil Pressure Failure

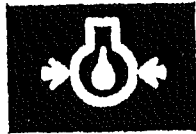

If the machine is in normal operation, this lamp stays off. When the starter switch is turned to "RUN" position to start the engine, the lamp goes on, and when the oil pressure rises after startup, it goes off. If this lamp goes on during operation, the emergency stop device immediately operates to shut down the engine automatically. After the engine stops, the lamp stays on unless the starter switch is turned to "STOP" position.

③ Fuel Level Failure



When fuel is running low, this lamp goes on, and the tank should be filled.

④ Battery Fluid Level Failure



When battery fluid runs low, this lamp goes on, and distilled water should be supplied to the battery.

(17) Frequency Meter

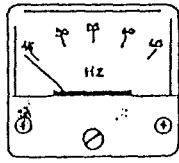

This meter indicates the power frequency. Make sure that the meter pointer stands at 50 or 60Hz during operation.

(18) AC Ammeter

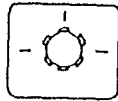
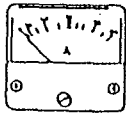

The ammeter indicates the value of current flowing in the load connected. Make sure that the current value is below that rated. Use the ammeter change-over switch to check each phase for current value.

(19) AC Voltmeter

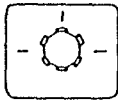
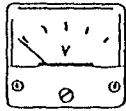

The voltmeter indicates the output voltage. Make sure that the voltmeter pointer stands at the rated voltage. Use the voltmeter change-over switch to check each phase for voltage value.

(20) Voltage Regulator



This regulator is used to control the output voltage. Turn the regulator clockwise to increase the voltage and counter-clockwise to decrease it. Adjust the voltage to the rated voltage with this regulator.

(21) Air Circuit Breaker

Refer to the item 3-2

(22) AC Wattmeter

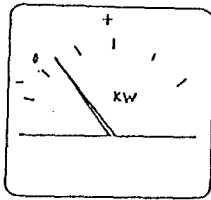

Indicates output(kW) of the generator. Always operate the generator at the rated output or less. The rated output is shown below:

- 50 Hz . . . . 560 kW
- 60 Hz . . . . 640 kW

Should the generator power be reversed during parallel operation, the wattmeter will indicate negative values.

(23) Stator thermometer

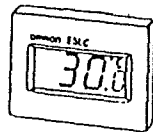

Indicates the temperature of the generator armature.

Measurement range : 30 °C to 110 °C

(24) Bearing thermometer

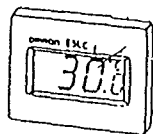

Indicates the temperature of the generator bearing.

Measurement range : -20 °C to 60 °C

Note 1. Their thermometers display errors as below.

■ Error Displays

- Temperature is below the thermometer's measurable range.
- FFF Temperature is above the thermometer's measurable range.
- Flashing --- Temperature sensor's lead wire has broken.
- Flashing FFF Temperature sensor has short circuited.

Note 2. Their's battery life is 10 years min.

Only battery cannot be changed. If the battery is discharged, change a complete set (display, sensor and leadline)

(25) Overcurrent Relay

- a) Each set value for the overcurrent relay factory-adjusted with the performance of the generator. Do not modify any set values.
- b) When the relay is actuated, the indicator (orange) is lit on to display the cause of such actuation. Display of tripping indicates the phase at which the trouble current was largest. Should the indicator display "instantaneous", there is a large possibility of short circuit. In any case, check the cause.

Display of the indicator

Troubles	Indicator	Tripping		Instantaneous
		Phase R	Phase T	
Over-load	Between R and S (U-V)	●	—	—
	Between S and T (V-W)	—	●	—
	Between T and R (W-U)	●	●	—
	Between R, S and T (U-V-W)	(IR>IT)	(IT>IR)	—
Short circuit	Between R and S (U-V)	●	—	●
	Between S and T (V-W)	—	●	●
	Between T and R (W-U)	●	●	●
	Between R, S and T (U-V-W)	(IR>IT)	(IT>IR)	●

Note: IR=current in phase R. IT=current in phase T.

- c) A set of five LED's provided on the surface of the relay will indicate the operating conditions of the relay.

3-2 HANDLING THE AIR CIRCUIT BREAKER

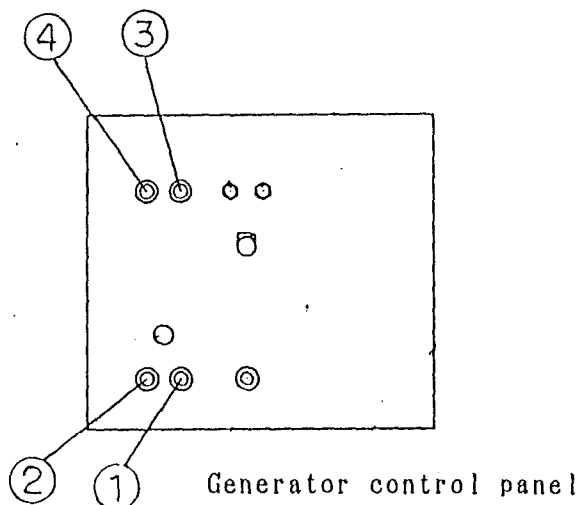

- ① Circuit breaker ON button
- ② Circuit breaker OFF button
- ③ Circuit breaker ON lamp
- ④ Circuit breaker OFF lamp

[Electromagnetic operation]

1) Closing

The circuit breaker is closed by pressing the push button switch "ON" on the control panel, and the circuit breaker ON lamp is lit.

## 2) Opening

The circuit breaker is opened by pressing the push button switch "OFF" on the control panel, and the circuit breaker OFF lamp is lit  
(Manual operation)

The air circuit breaker may be manually operated. However, limited the manual operation to maintenance and inspection prosedures and to emergency where it cannot be electromagnetically operated.

The air circuit breaker is located on the right side of the control box. First, remove the protective cover from the control box.

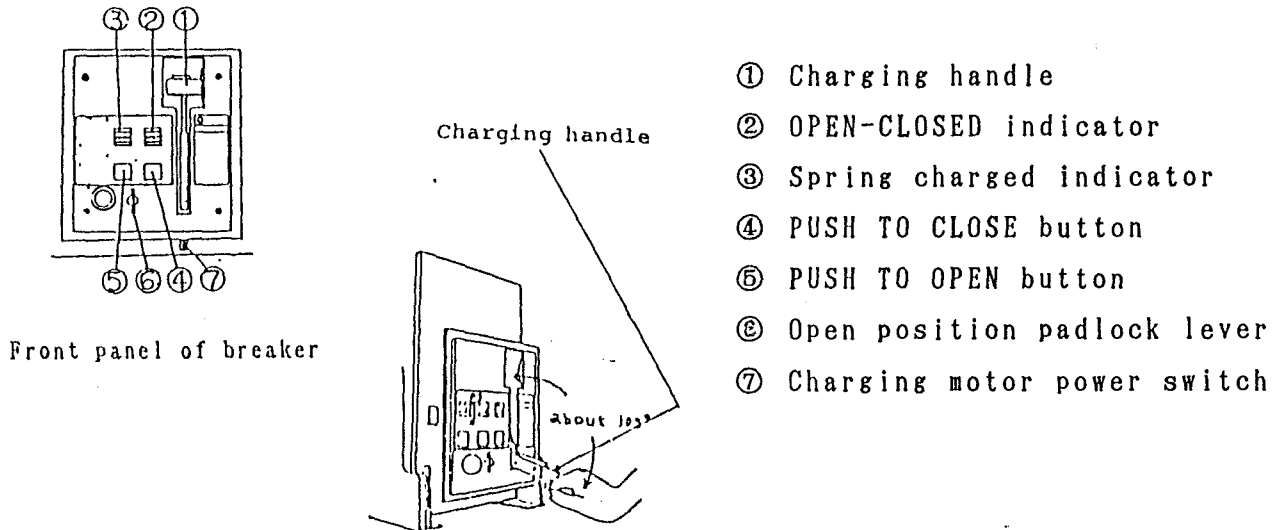

### 1) Spring charging operation

Pump the charging handle. When the closing springs are fully charged, a metallic "click" will be heard and no further pumping of the charging handle of the charging handle will be possible. When the charging handle is pumped with its maximum stroke, about four pumping cycles will complete the charging. Check that the spring charged indicator shows "CHARGED".

### 2) Closing operation

Open the clear shutter upward and press the PUSH TO CLOSE button. This release the charged closing springs and the breaker is closed. The OPEN-CLOSED indicator shows "CLOSED", and the spring charged indicator shows "DISCHARGED".

### 3) Opening operation

Open the clear shutter upward and press the PUSH TO OPEN button. This trips open the breaker, and the OPEN-CLOSED indicator shows "OPEN".

## 4. PREPARATION FOR OPERATION

### 4-1. Precautions In Installation

Install the machine horizontally on solid ground.

In addition, when the machine is to be installed in a place where dust and salt are excessive, pay close attention to its maintenance and care to prevent radiator clogging and failure, and electrical-part insulation failure possibly caused by operation under such circumstances.

#### (1) Precautions In Outdoor Installation

When the machine is to be install outdoors such as on the road, pay attention to the wind direction and the exhaust port position so that the exhaust gas it away from pedestrians and nearby buildings.

#### (2) Precautions In Indoor Installation

- ① Leave enough space for easy operation and control on the control-panel side ( at least 1 m )
- ② Leave enough space for engine inspection, lubrication, connection of cable to the load, fuel supply and other operations both on the right and left sides viewd from the control panel (at least 1 m ).
- ③ Install an exhaust pipe so that exhaust gas is discharged through it to an open area.
- ④ Leave enough space for exhaust of warm air discharged through the radiator, supply of water to the radiator, and arrangement of the exhaust pipe above the machine.
- ⑤ Note that the connection of the generator to indoor wiring not only infrings the law, but also may cause electrocutiion or generator failure.
- ⑥ Note that the machine can be installed directly on a foundation such as concrete.
- ⑦ Install the machine in such a place as can be thoroughly ventilated to prevent a considerable rise in the indoor temperature, which has an adverse effect on the engine generator.



#### 4-2. Check Before Startup

Be sure to check the machine especially for the following points before startup to minimize machine failure.

##### (1) Check Oil

\* Be sure to check the oil level before startup every day.

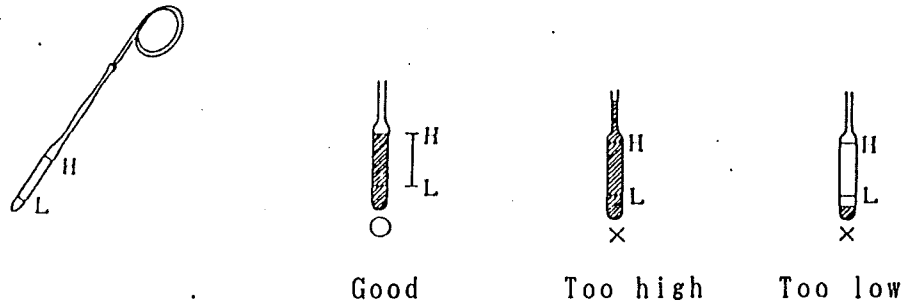

Note : Some engine manufactures provide a level gauge with such H/L marks on both sides, which allows the oil level to be checked during idling. When using such a level gauge, carefully check which of the two H/L marks is used at downtime or during idling.

- \* Check engine oil with an oil level gauge to see that the oil level is in between marks H and L of the level gauge, and replenish or replace it if necessary.
- \* For oil replenishment, supply a given amount of oil from the oiling port provided on the engine.
- \* After a specified amount of oil engine is supplied, run the engine for several minutes and then stop it to check again to see that the oil level stands in between marks H and L of a level gauge.

Notes : For specified quantity of lubricating oil, refer to the Specifications Table.

##### (2) Check Cooling Water

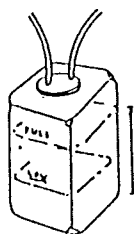

Put water  
to "FULL"

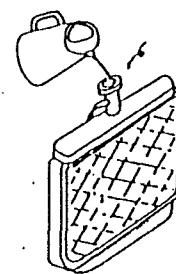

In checking or supplying cooling water, make sure that the engine is cold. For cooling water in winter, refer to the "Engine Instruction Manual".

Use tap water as cooling water and put it up to the root of the filling port. Some machines are provided with a reserve tank. Put tap water in it up to the "FULL" mark.

In setting the radiator cap after the cooling water check or supply, take care to turn it clockwise to full position so that the radiator can be used with its inside kept in a pressurized state. Insecurely-tightened radiator cap may result in serious engine trouble.

Notes : For specified quantity of cooling water, refer to the Specifications Table.

### (3) Check Fan Belt

Check the belt for tension and elongation. Adjust them if necessary. If any abnormality is found on the belt, replace it. Perform the adjustment and replacement as directed in "Engine Instruction Manual".

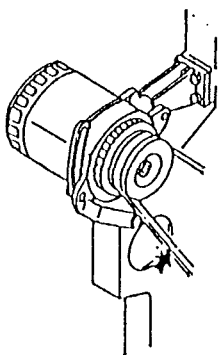

The belt tension is considered to be proper if the flexing level is within 10-15 mm when the arrow-indicated portion (belt center) is pressed with the thumb (approximately 6kg).

### (4) Check Fuel

Be sure to check the fuel level before startup to prevent fuel shortage during operation. Occasionally remove sediment and contaminated water collected in the bottom of the fuel tank by loosening its drain plug.

Frequency	50Hz	60Hz
Fuel Consumption(l/hr)	138	165

(5) Check Generator Case Grounding

When the generator is installed in a moist place, or on highly conductive material such as iron plates or steel-work, be sure to connect the grounding wire terminal provided near the output terminal block and bury the wire 50 cm or deeper in the ground securely.

Do not directly ground terminal "0".

Recommended grounding wire sectional area: 5.5 mm<sup>2</sup> or larger

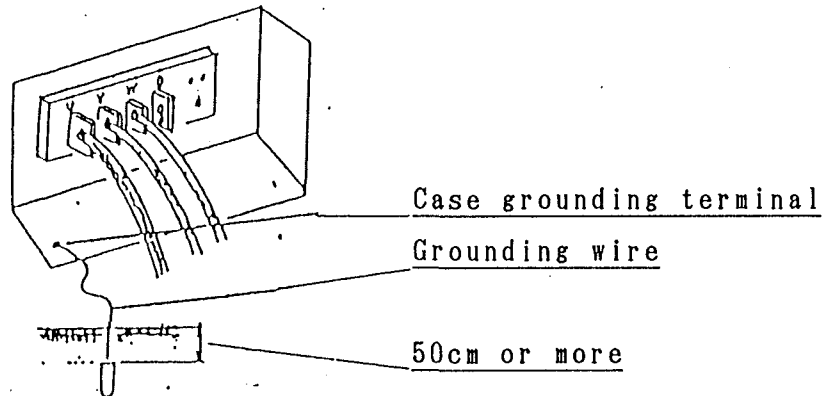

(6) Check For Water And Oil Leakage

Check the engine periphery for water and oil leakage. If such leakage is found, identify the leak spot and repair it

(7) Check Bolts And Nuts For Looseness

Check bolts and nuts, especially on the air cleaner, muffler and turbo-charger mounting portion, for looseness and tighten them if necessary.

(8) Check Electrical Wiring For Disconnection, Short And Terminal Looseness.

#### 4-3. Load Connection

In connecting a load, tighten locking bolts securely with a spanner, etc. to prevent burning.

##### (1) Three-phase Output

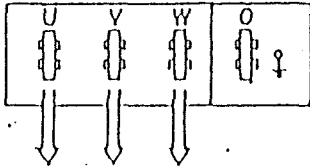

Use U/V/W for three-phase load  
200/220V or 400/440V  
(380V)  
{415V}

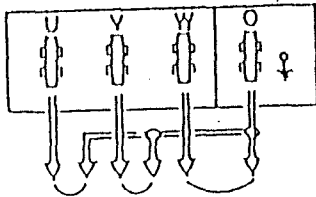

Use O/U, O/V, O/W for single-phase load  
115/127V or 231/254V  
(220V)  
{240V}

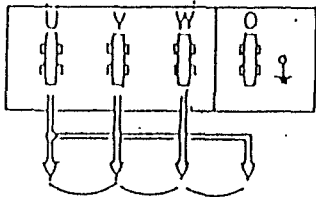

Use U/V, V/W, W/U for single-phase load  
200/220V or 400/440V  
(380V)  
{415V}

Select voltage according to the voltage of the load to be used.

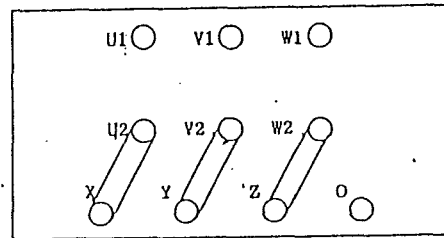
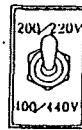
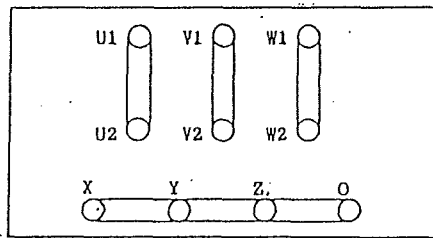

200/220V

400/440V (380V){415V}

\* Method For Selecting Output Voltage

The output voltage of 200/220V or 400/440V, (380V), {415V} can be selected with the voltage changeover plates.

These generators are shipped from the plant with their output voltage set at 200/220V unless otherwise specified.

Change over to the desired output voltage according to the following procedure, if necessary.

- ① The voltage changeover panel is located on the side of the control box.

Open the side cover to remove the set screw.

- ② Change over to the desired output voltage by setting the changeover plates and the changeover switch on its side as shown in the above drawing.

Note that insecure tightening of the locking bolts results in burning.

- ③ In changing the output voltage over to 400/440, take care not to lose superfluous changeover plates by, for example, setting them together with the actually used ones.

☆ Precautions In Load Connection

- ① Be sure to provide a switch for turning the load ON and OFF between the output terminal block and the load.

Note that the use of the generator breaker for turning the load ON and OFF may result in breaker failure.

- ② In connecting the load, be sure to stop the engine and turn OFF the Air Circuit Breaker before load connection.

#### 4-4. Cable Selection

Select a properly-thick cable taking into consideration its allowable current and the distance between the generator and the load.

The load current flowing through a cable in excess of its allowable current may cause overheating with resultant burning, and the use of a cable that is too thin for its length may result in decreased input voltage to the electrical instruments, causing them to operate with low power or be inoperative.

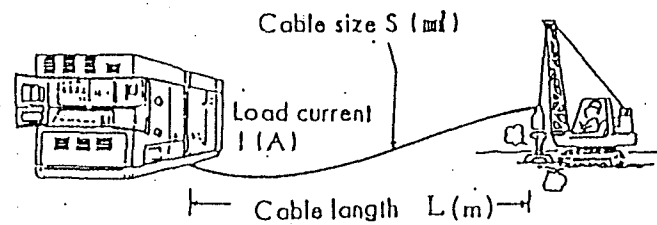

The voltage drop across a cable can be determined from its load current, length and thickness according to the following simplified equation for three-phase three-line system:

$$e = 1/58 \times L/S \times I \times \sqrt{3}$$

where e; Voltage drop (V), L; Cable length (m)

S; Cable thickness (mm ) and I; Load current (A).

Select the cable length and thickness so that the voltage drop can be held to within 5%.

## 5. OPERATION

### 5-1. Automatic Idling Device

This device automatizes the idling of the engine for its warming-up after startup .

### 5-2. Operation For and After Startup

#### (1) Automatic Operation

- ① Turn the Speed Changeover Switch on the control panel to "AUTO.IDLING" position.
- ② Set the Frequency Change-over S.W.(50 or 60Hz) on the control panel to the frequency to be used.
- ③ Turn the Battery Switch "ON". At this time, check the Running Caution Lamp is off. If the lamp goes on, turn the Battery Switch to the "OFF" position and then to the "ON" position again before checking that the lamp is "OFF".
- ④ Turn the Starter Switch to "START" position slowly to start up the engine. When the engine starts to run, release the Starter Switch.

After engine startup, make sure that the OK monitor "Oil Pressure Failure" lamp is off.

Idling at a low speed and the Running Caution Lamp goes on. Check that, in about 20 seconds, the low-speed idling automatically changes over to operation at the high speed preset with the Throttle Lever.

- ⑤ If the idling speed is found not to be as specified, correct it according to the following table.

	Idling Speed (Frequency)
50Hz Operation	1575rpm (52.5Hz)
60Hz Operation	1875rpm (62,5Hz)

- ⑥ Set the voltage to that specified with the Voltage Regulator and push the "ON"button of the Air Circuit Breaker.

- ⑦ Adjust the Throttle Lever and the Voltage Regulator so that the Tachometer, Frequency meter and AC Voltmeter will stand as in upper drawing for 50Hz operation and as in the lower for 60Hz.

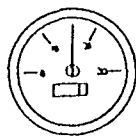

Tachometer  
1500rpm

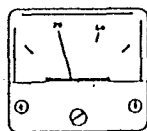

Frequency meter  
50Hz

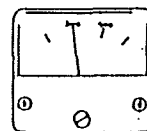

AC Voltmeter  
200/400V  
(380V){415V}

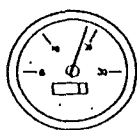

Tachometer  
1800rpm

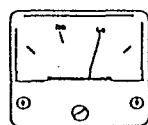

Frequency meter  
60Hz

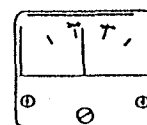

AC Voltmeter  
220/440V

(2) Continued Low-Speed Operation

Turn the Speed Changeover Switch on the control panel to "LOW" position.

If the above changeover is made after startup, the idling performed for a given time after startup is followed by the low-speed operation continuing until the changeover switch is turned to "AUTO.IDLING" position.

(3) To change over to high-speed operation soon after startup

(for restart when it is sufficiently warmed up)

Turn the Speed Changeover Switch on the control panel to the "HIGH" position. This switch setting releases the automatic idling function, allowing the engine to be run at the speed set by the Throttle Lever and the Frequency Change-over switch.



#### 5-4. Check After Startup

- (1) Check the gauges and lamps for normal operation.
- (2) Check the engine for exhaust color, sound and vibration.
- (3) Check for oil, fuel and water leakage.

#### (4) Precautions During Operation

- ① Do not change the switch over to "LOW" during load operation.

In addition, do not start up the engine with the generator and load-side breaker set at "ON" position.

Note that the generator voltage and frequency stand so low during idling operation that the loading instruments may operate but function improperly. During this period, the Running Caution Lamp stays on to warn of this state.

- ② Do not turn off the Battery Switch or remove the battery during operation.

- ③ If the operation, stopped by operations other than the Starter Switch "STOP" operation (eq. use of Emergency Stop Button, actuation of the emergency stop device, fuel shortage, engine failure ) is to be restarted, first turn the Starter Switch to "STOP" position or the Battery Switch to "OFF" position before performing the ordinary startup operation.

#### 5-5. Shutdown

- (1) Turn the load-side beaker to the "OFF" side.
- (2) Push the "OFF" button of the Air Circuit Breaker.
- (3) Place the Speed Changeover Switch in the "LOW" position, and continue to run the engine for about several minutes.
- (4) Turn the Starter Switch to the "OFF" position.

The engine immediately stops.

- (5) Finally, turn the Battery Switch "OFF".

- (6) For emergency stop, press the Emergency Stop Button.

#### 5-6. Emergency Stop Device

If any abnormal engine oil pressure failure or water temperature rise occurs during operation, this device shuts down the engine automatically.

#### 5-7. If Automatic Idling Device is defective

With the Speed Changeover Switch set at the "HIGH" position, operate the engine from startup to stop. The engine always runs at the speed set by the Frequency Change-over switch.

- \* Adjust the startup speed, and high-speed operation speed with the Throttle Lever and the Frequency change-over s.w. The engine will not stop if the Starter Switch is turned to the "STOP" position.

To stop the engine, press the Emergency Stop Button.

## 6. PARALLEL OPERATION

This section describes the parallel operation .

It should be noted here that an efficient parallel operation of engine generators can be attained using the same type.

### 6-1. Preparation For Parallel Operation

(1) Make connection between generators and wire them to the load according to the terminal symbols as shown in the following drawing.

\* The generators are shipped with the phase sequence set in the order of U , V and W.

Check the phase sequence with a phase meter.

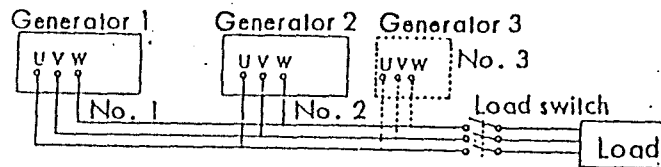

- (2) When generators designed for double voltage ( 200/220V or 400 /440 ) are to be used, change all of their output voltages over to the operating voltage.
- (3) Turn the "SINGLE-PARALLEL" changeover switches on the control panels of all the generators to "PAR" position.
- (4) Turn the breakers of all the generators "OFF".

## 6-2. Operation

- (1) Turn the load switch "OFF".
- (2) Warm up all the generators.
- (3) Set the all-generator frequency (speed) and voltage to the respective same values with the Throttle Lever and Voltage Regulator, respectively. This setting requires little subsequent adjustment with the Voltage Regulator.
- (4) Turn the Breaker of No.1 generator "ON".
- (5) Adjust the Throttle Handle so that the Synchronizing Lamp of No.2 generator goes on and off at intervals of as long as 5 to 10 seconds.

Then , turn the Breaker of No.2 generator "ON" the moment the Synchronizing Lamp of this generator goes off for parallel operation.

Repeat the same operation to put No.3 and the following generators, if any, in parallel operation.

Note: The Synchronizing Lamp of No.2 generator goes on and off simultaneously with that of No.1 generator if both are synchronized with each other in the phase sequence. If not, they alternately go on and off. In such cases, reverse any two of connections U , V and W between the generators.

- (6) Note that the generators should have no load applied to them under this condition with no AC current flow.  
If the AC Ammeter pointer stands out of "0", mark the zero-point adjustment with the Voltage Regulator.
- (7) Turn on the load switch. If the generators are found not to be uniform in load current, make adjustments by changing the engine speed with the Throttle Lever. Turn the Throttle Lever to "HIGH" side to increase the load share and to "LOW" to decrease it.

### 6-3. Precautions

- (1) Adjust the Throttle Lever so that the generators are equal in their load shares during parallel operation.
- (2) In operating the generators individually, be sure to turn the "SINGLE-PARA" changeover switches to "SINGLE" side.
- (3) Do not turn the Speed Changeover Switch to "LOW" position during parallel operation.

## 7. STORAGE

### 7-1. Daily Storage

Store the generator horizontally in a place where it will not be exposed to moisture, salt and dust.

### 7-2. Long-term Storage

Observe the same precautions as taken for daily storage.

For long-term storage of the engine, refer to "Engine Instruction Manual" supplied by the manufacture.

### 7-3. Two-tier Stacking Of Generators

The generator is designed for two-tier stacking to allow effective place utilization. In stacking the generators in two tiers, observe the following points.

- (1) Stack the generators horizontally on a firm ground.
- (2) Do not stack any machine heavier than this machine.
- (3) Place square bars between the generators as illustrated in the drawing.
- (4) Stack the generators so that the weight of the upper is applied to the lower uniformly.
- (5) In stacking the generators, place one on the other as gently as possible.

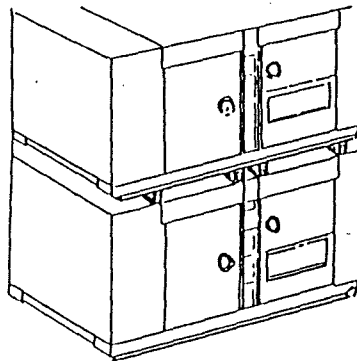

## 8. MAINTENANCE AND INSPECTION

### 8-1. Generator

#### (1) Bearing

The generators, supply grease to the bearings every 250 hours so that the grease quantity is about 1/3 of the bearing-chamber volume.

#### (2) Insulation Resistance

Measure the insulation resistance with a 500V-megger at least once every month to check for not less than one megohm.

##### \* Measuring method and allowable limit

As illustrated in the following drawing, remove the load-side wire from the output terminal block, turn the breaker "ON" and measure the insulation resistance between the output terminal bolt and bonnet.

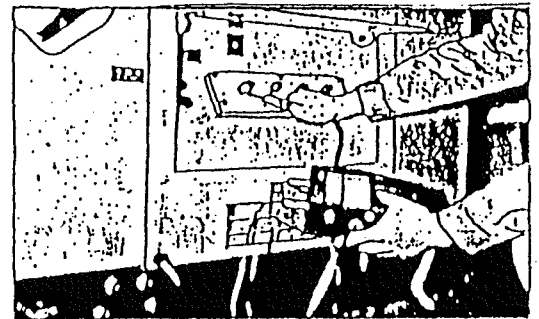

If the insulation resistance thus measured is found to be 0.5 megohm or below, repair the trouble spot to prevent electrocution and fire possibly caused otherwise.

### 8-2. Control Box

Check the measuring instruments for normal operation.

### 8-3. Engine

Perform daily and periodic inspections according to the attached "Engine Instruction Manual".

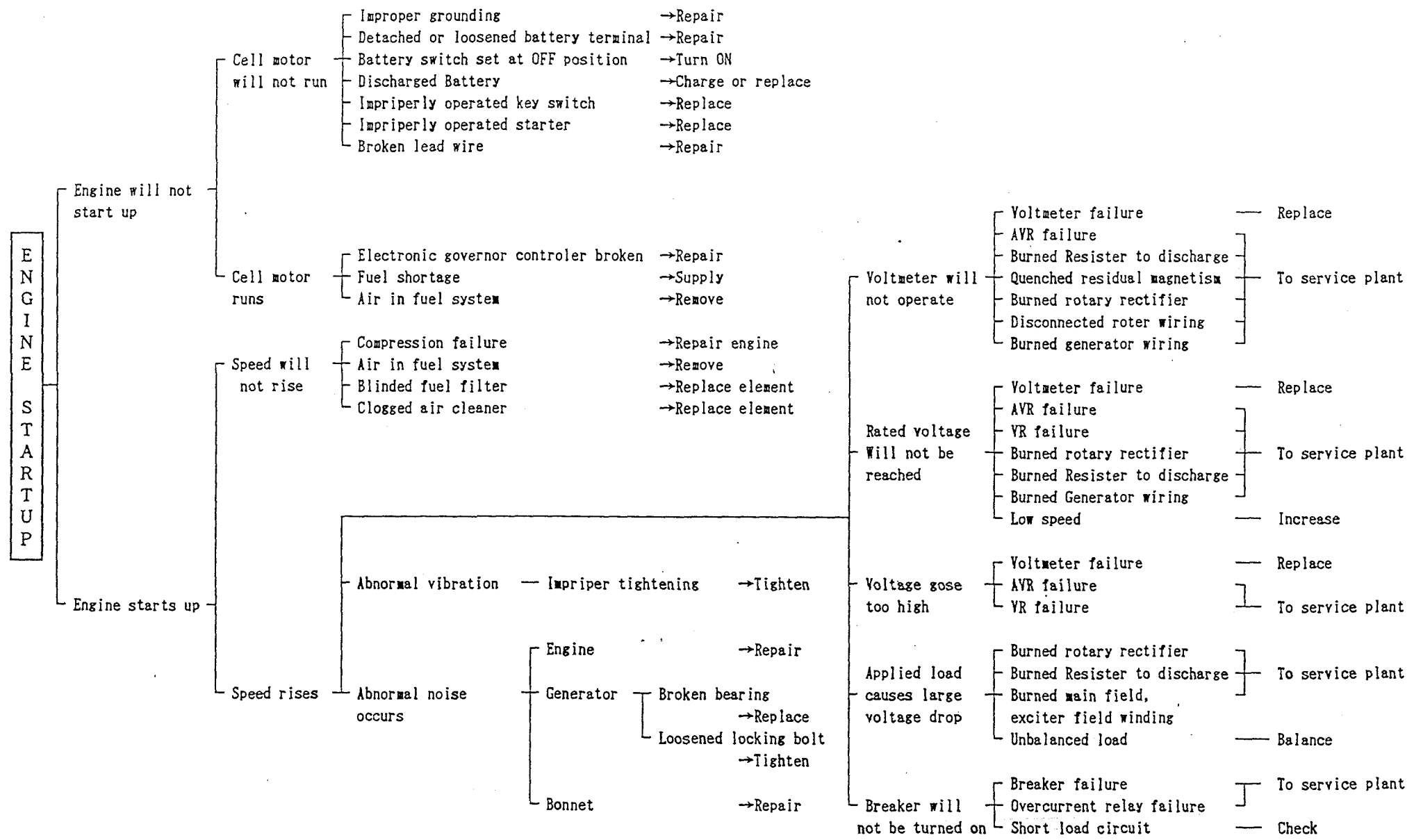

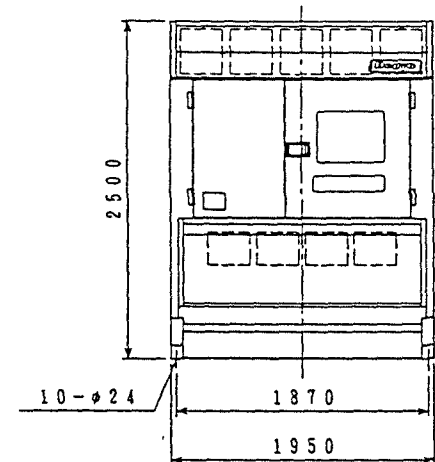
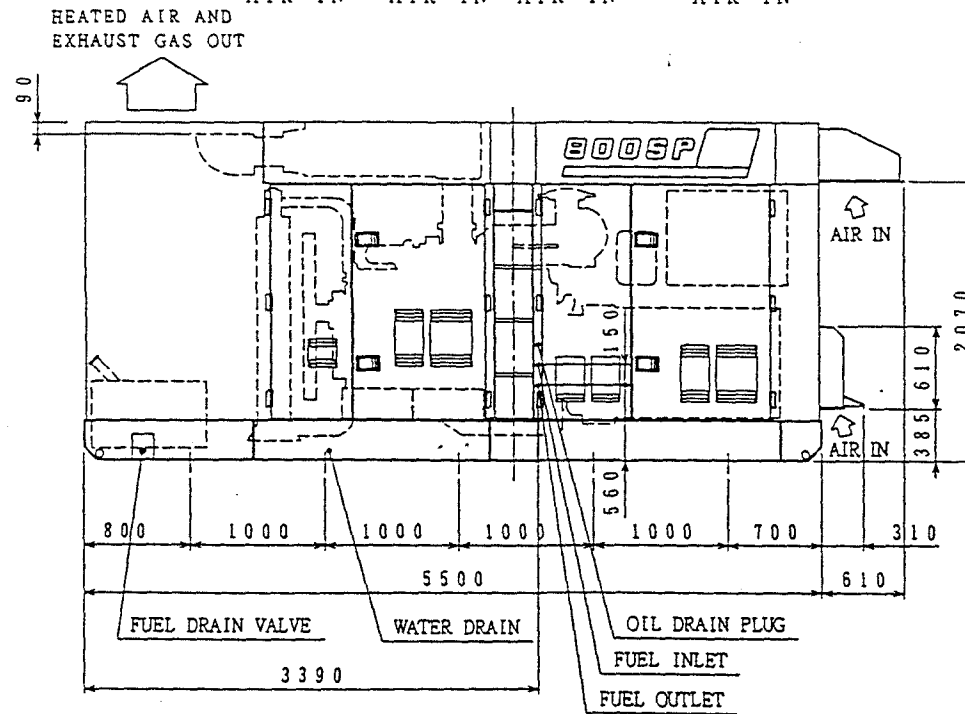
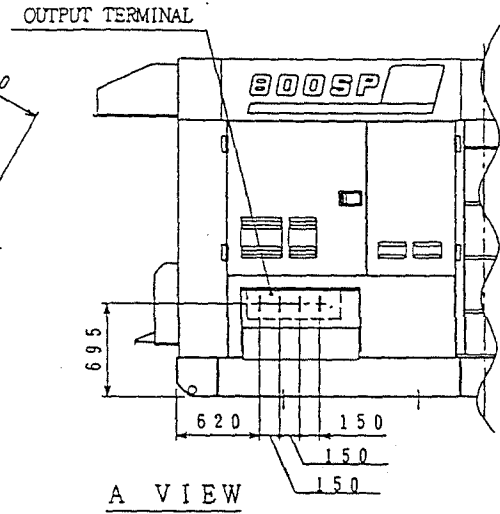
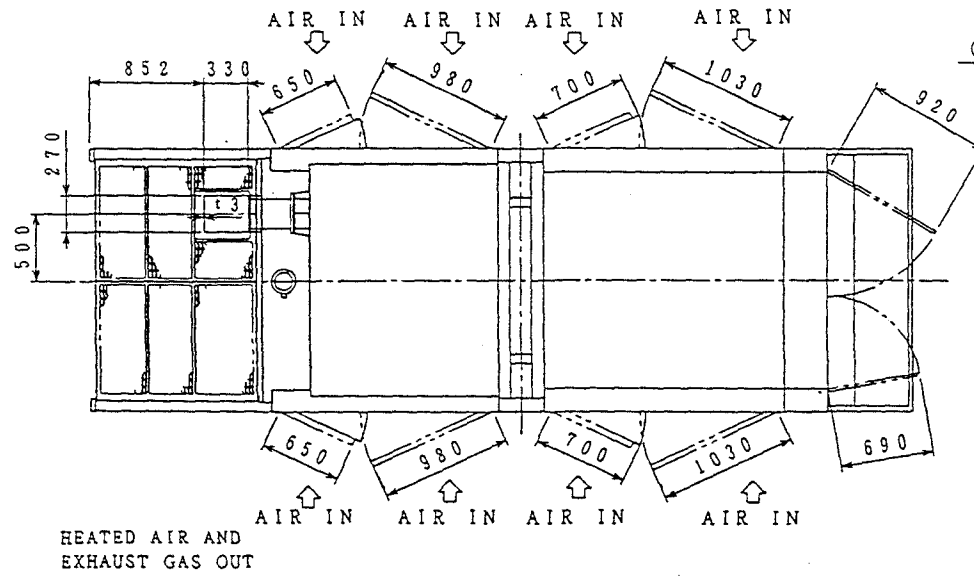

ENGINE : KOMATSU SA12VI40  
 GENERATOR : DF-8800  
 BATTERY : 12V-200Ah×4  
 FUEL TANK : Approx. 490ℓ  
 DRY WEIGHT: Approx. 11200 kg

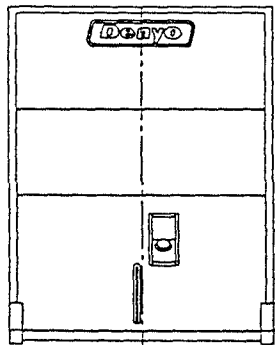



# 1 1 . CONTROL AND OPERATING PANEL

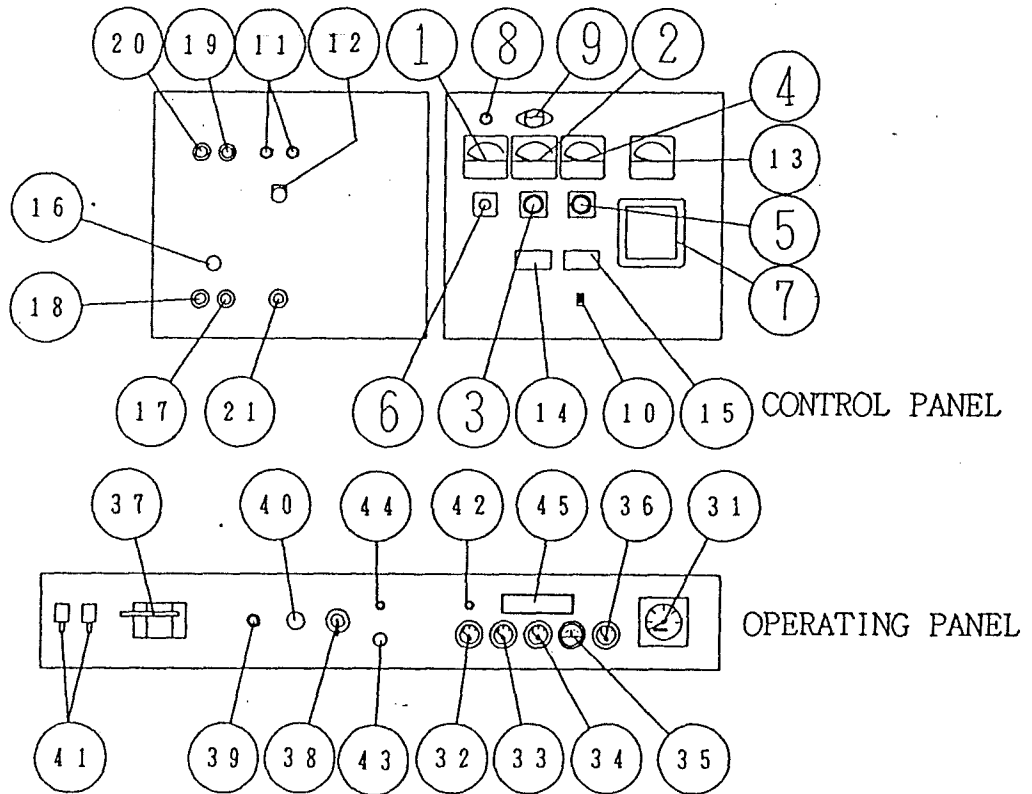

CONTROL PANEL		OPERATING PAENL	
No.	NAME	No.	NAME
1	FREQUENCY METER	3 1	TACHOMETER
2	AC AMMETER	3 2	OIL PRESSURE GAUGE
3	AMMETER CHANGE-OVER SWITCH	3 3	OIL TEMP. GAUGE
4	AC VOLTMETER	3 4	WATER TEMP. GAUGE
5	VOLTMETER CHANE-OVER SWITCH	3 5	CHARGING AMMETER
6	VOLTAGE REGULATOR	3 6	FUEL GAUGE
7	OVER CURRENT RELAY	3 7	BATTERY SWITCH
8	PILOT LAMP	3 8	STARTER SWITCH
9	PANEL LIGHT	3 9	EMERGENCY STOP BUTON
1 0	PANEL LIGHT SWITCH	4 0	PREHEAT LAMP
1 1	SYNCHRONIZING LAMP	4 1	AIR CLEANER INDICATOR
1 2	SING -PAR CHANGE-OVER SWITCH	4 2	ALARM LAMP, OIL FILTER
1 3	AC WATTMETER	4 3	SPEED CHANGE-OVER SWITCH
1 4	STATOR TEMP. GAUGE	4 4	RUNNING CAUTION LAMP
1 5	BEARING TEMP. GAUGE	4 5	OK MONITOR
1 6	FREQUENCY CHANGE-OVER SWITCH		
1 7	CIRCUIT BREAKER SWITCH		
1 8	CIRCUIT BREAKER RESET SWITCH		
1 9	CIRCUIT BREAKER (ON) LAMP		
2 0	CIRCUIT BREAKER (OFF) LAMP		
2 1	THROTTLE LEVER		

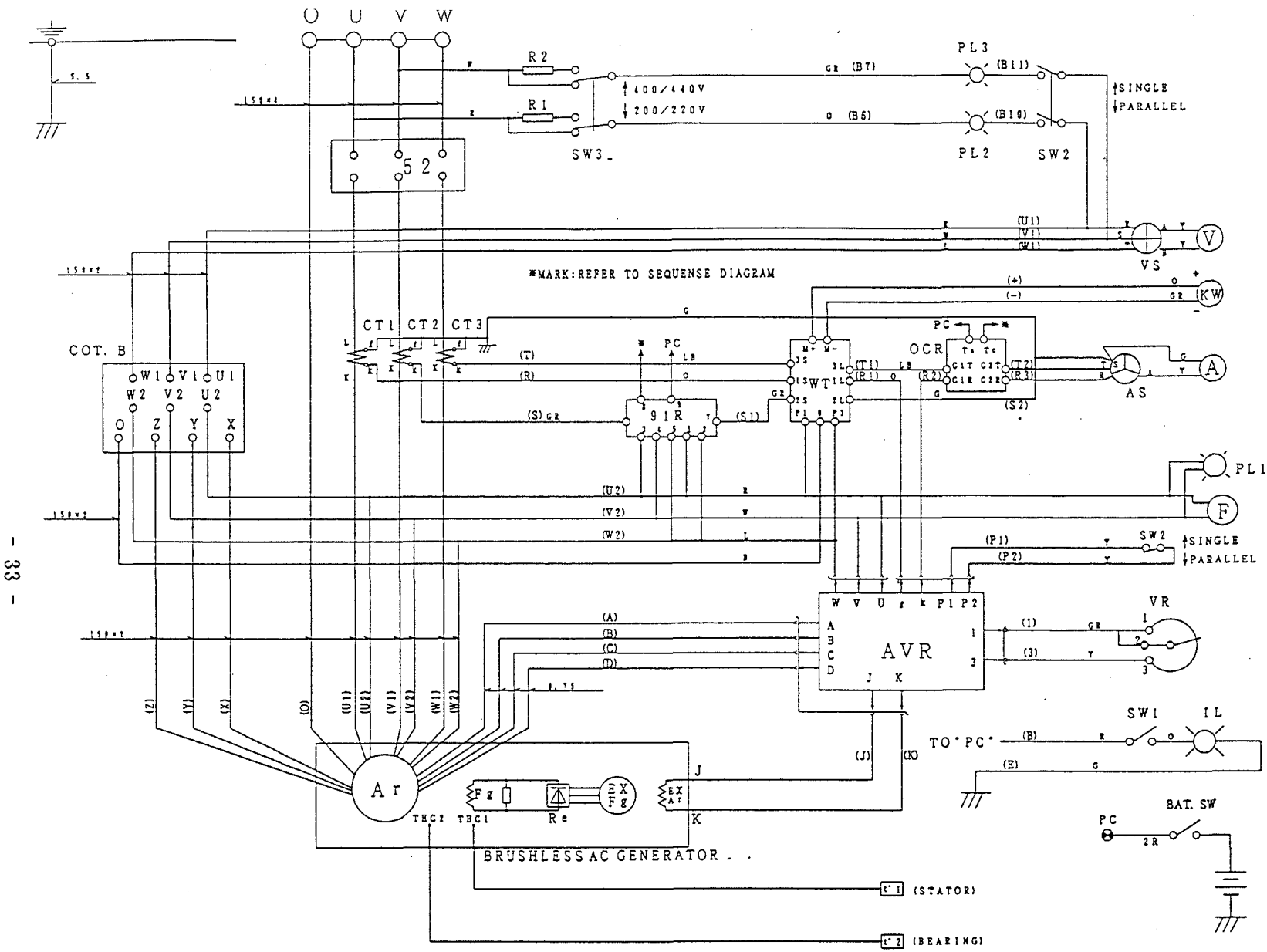

MARK	N A M E
Ar	MAIN GENERATOR ARMATURE WINDING
Fg	MAIN GENERATOR FIELD WINDING
ExAr	EXCITER ARMATURE WINDING
ExFg	EXCITER FIELD WINDING
AVR	AUTOMATIC VOLTAGE REGULATOR
VR	VOLTAGE REGULATING RHEOSTAT
Re	RECTIFIER
CT1-3	CURRENT TRANSFORMER 1500/5A
52	CIRCUIT BREAKER 2500A
OC	OVER CURRENT RELAY
COT. B	VOLTAGE CHANGE-OVER BOARD
AS	AMMETER CHANGE-OVER SWITCH
A	AC. AMMETER 0-1500, 3000A
VS	VOLTMETER CHANGE-OVER SWITCH
V	AC. VOLTMETER 0-600V
F	FREQUENCY METER 45-65Hz
PL1	PILOT LAMP
PL2, 3	SYNCHRONIZING LAMP
R1, 2	RESISTOR
SW2	SINGLE PAR. CHANGE-OVER SWITCH
SW3	VOLTAGE CHANGE-OVER SWITCH
IL	PANEL LIGHT
SW1	PANEL LIGHT SWITCH
91R	REVERSE POWER RELAY
KW	WATTMETER
WT	WATTMETER TRANSDUCER
T' 1	STATOR TEMP. GAUGE
T' 2	BEARING TEMP. GAUGE
THC1, 2	TEMPERATURE SENDER

- 33 -

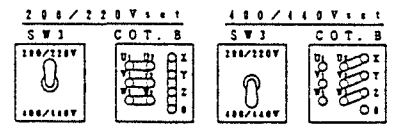

WIRE SIZE	COLOR CODE
150: 150mm <sup>2</sup>	WIRE COLOR
38: 38mm <sup>2</sup>	B BRACK R RED
22: 22mm <sup>2</sup>	L BLUE W WHITE
14: 14mm <sup>2</sup>	BR BROWN Y YELLOW
5.5: 5.5mm <sup>2</sup>	G GREEN LB LIGHT BLDE
2: 2mm <sup>2</sup>	GR GRAY LG LIGHT GREEN
	V VIOLET O ORANGE
NO MARK: 1. 25mm <sup>2</sup>	P PINK

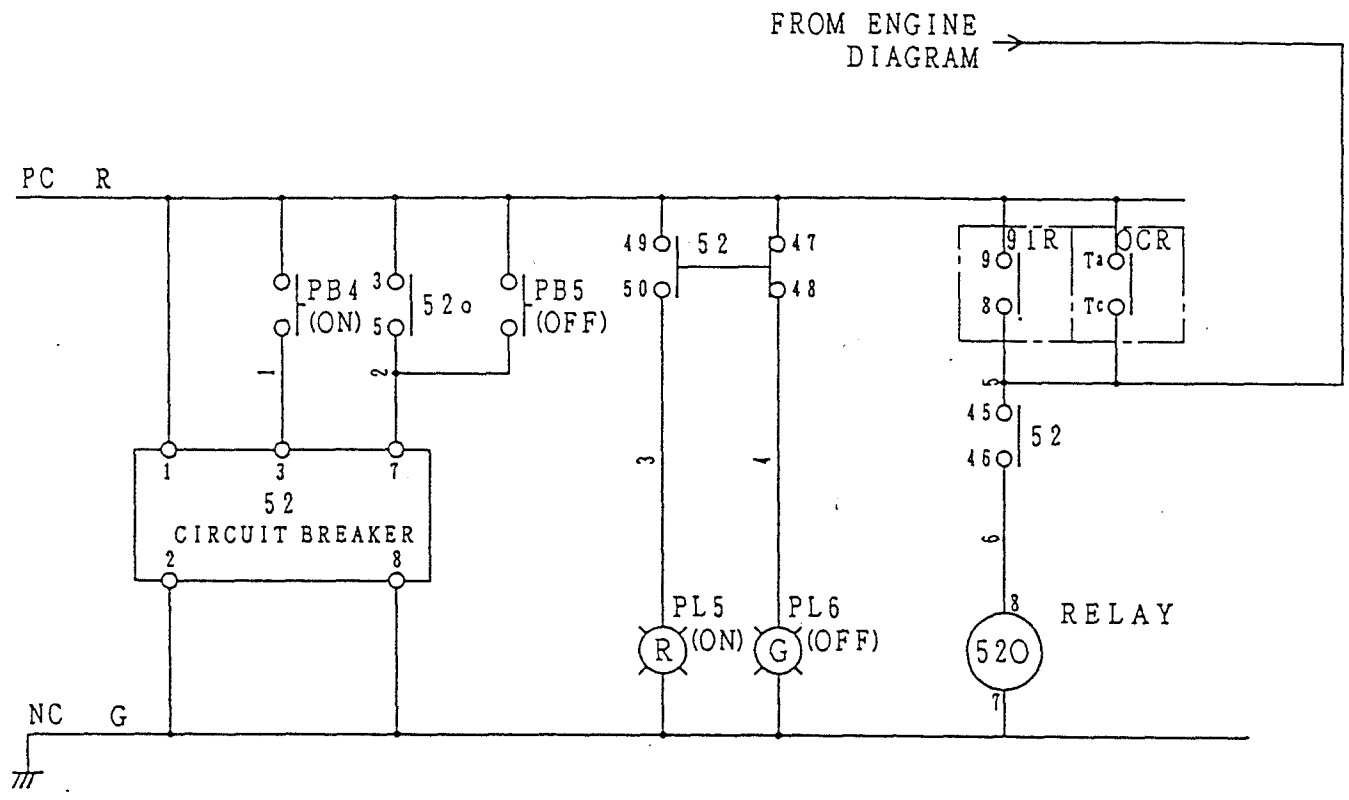

COLOR CODE			
	WIRE COLOR		WIRE COLOR
B	BLACK	R	RED
L	BLUE	W	WHITE
BR	BROWN	Y	YELLOW
G	GREEN	LB	LIGHT BLUE
GR	GRAY	LG	LIGHT GREEN
V	VIOLET	O	ORANGE
P	PINK		

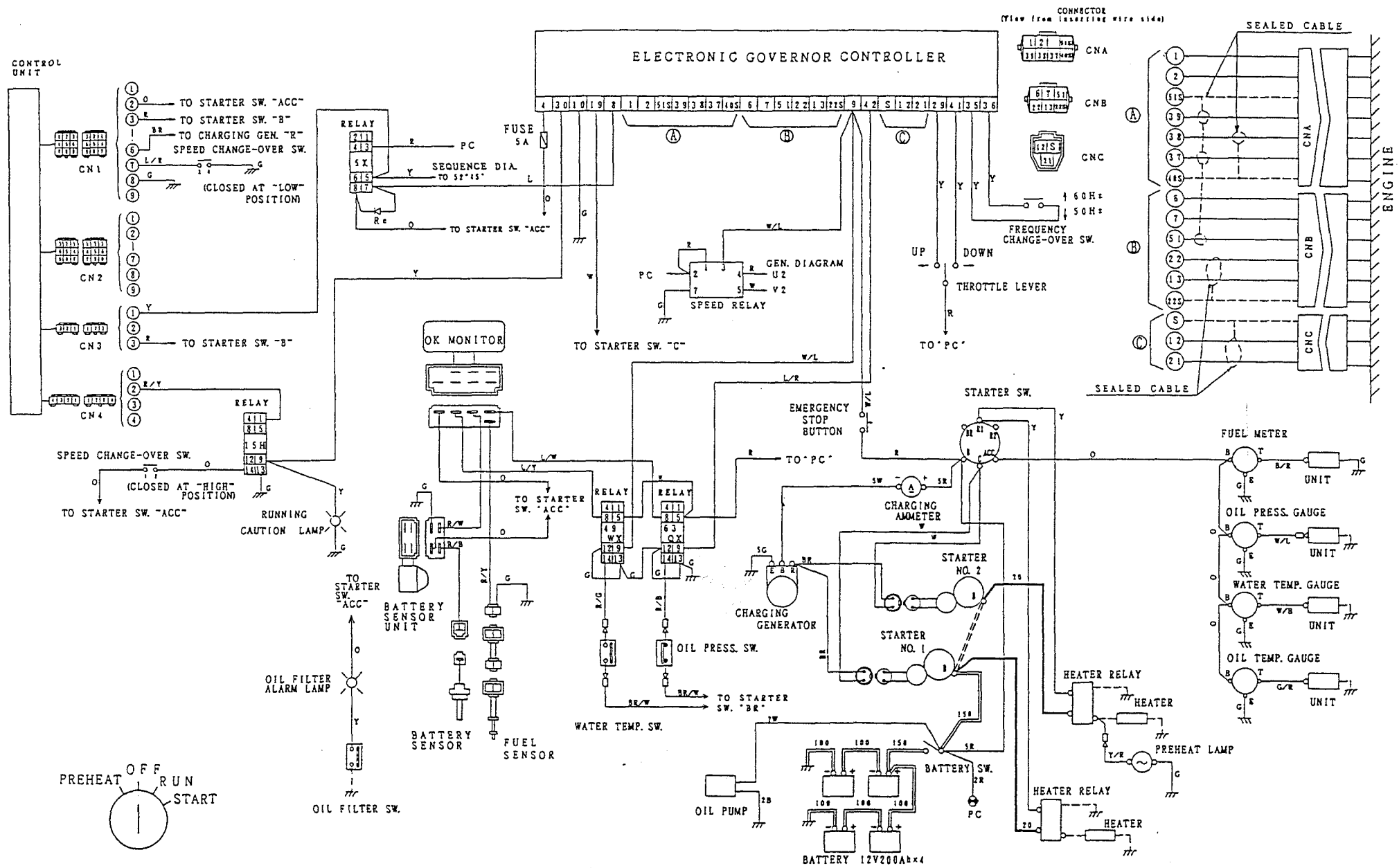

- 35 -

	STARTER SW. CONNECTION					
	B	BR	R1	R2	C	ACC
OFF	○					
PREHEAT	○	○				
RUN	○		○			
START	○			○		○

WIRE SIZE	COLOR CODE
150: 150mm <sup>2</sup>	WIRE COLOR
100: 100mm <sup>2</sup>	B BRACK R RED
20: 20mm <sup>2</sup>	L BLUE W WHITE
5: 5mm <sup>2</sup>	BR BROWN Y YELLOW
2: 2mm <sup>2</sup>	G GREEN LB LIGHT BLUE
	GR GRAY LG LIGHT GREEN
	V VIOLET O ORANGE
NO MARK: 1.25mm <sup>2</sup>	P PINK

## 1 5. SAFETY PRECAUTIONS FOR DIESEL GENERATING SETS AND EQUIPMENT

To be read attentively before installing, operating  
or repairing the unit

- \* In addition to general safety rules which should be observed with diesel generating sets and equipment, the following safety directions and precautions are of special importance.
- \* When operating this unit, the operator is expected to employ safe working practices and to observe all related local work safety requirements and ordinances.
- \* The owner is responsible for maintaining the unit in a safe operating condition. Parts and accessories shall be replaced if unsuitable for safe operation.
- \* Installation, operation, maintenance and repair shall only be performed by authorized, trained, competent personnel.
- \* If any statement in this book, especially with regard to safety, does not comply with local legislation, the stricter of the two shall apply.
- \* These precautions are general and cover several machine types and equipment: hence some statements may not apply to the unit(s) described in this book.

#### 14-1. Installation

Apart from general engineering practices that conform with the local safety regulations, the following directives are especially stressed:

- ① Engine exhaust contains noxious elements.  
Therefore, pay close attention to ventilation when operating the generator set inside tunnels, buildings, or other enclosed areas.
- ② For outdoor operation, install the generator set so that the exhaust is not discharged in the direction of nearby homes or other enclosed areas.
- ③ When the generator sets is installed in a dusty or corrosive atmosphere, frequently inspect it for radiator clogging and other abnormal conditions.
- ④ Provide adequate space for engine inspection, lubrication, refueling, cable connection to the load, and operation.
- ⑤ Never remove or tamper with the safety devices, guards or insulations fitted on the unit.
- ⑥ Be sure that the generating set is on secure and level ground.

#### 14-2. Operation

- ① Select cables of proper thickness while referring to the load capacity and distance to the load. Then, securely connect them. Do not use any cable whose cover is broken and degraded. In connecting the cable, be sure to shut down the operation. Cover or tape the connections to prevent leakage and direct contact with the human body.
- ② Always set voltmeter and frequency meter at the rated. Set ammeter below rated current.
- ③ All canopy doors should be shut during operation.

- ④ People staying in environments or rooms where the sound pressure level reaches or exceeds 90 dB(A) shall wear ear protectors.
- ⑤ The following items should be checked before startup:
  - a) All guards should be in place and securely fastened.
  - b) Water, engine oil or fuel leakage
  - c) That all fasteners are tight
  - d) That all electrical leads are secure and in good order
  - e) Oil level and cleanliness
  - f) Cooling water level (radiator and overflow tank ) and radiator cap securely tightened
  - g) Fuel level
  - h) Tension of all V-belts
- ⑥ Provide a switch between the generator and load to operate or stop the load.
- ⑦ Always keep battery switch turned ON while operating the engine. Also, always keep it OFF when engine is not running.
- ⑧ Do not wire the generator set the interior circuit.
- ⑨ Avoid low-load operation for long periods of time.
- ⑩ Coolant: Use clean water.

When the temperature drops to (32 F) or below, the following measures must be taken:

  - a) Use antifreeze
  - b) When antifreeze is not used,

Open drain cocks of the engine and radiator to completely drain off cooling water after engine operation.
- ⑪ Fill the fuel tank frequently.

Periodically open the drain plug to drain moisture and contaminants.
- ⑫ Avoid high speed operation immediately after starting.
- ⑬ Never turn the starter switch to "START" position while the engine is running.
- ⑭ Never stop the engine suddenly except in an emergency.
- ⑮ Never touch any rotating, hot, and live parts during operation.

## 14-3. Maintenance

Maintenance and repair work shall only be carried out under supervision of someone qualified for the job.

- ① Use only the correct tools for maintenance and repair work.
- ② Use only genuine spare parts.
- ③ All maintenance work, other than routine attention, shall only be undertaken when the unit is stopped.
- ④ Never use flammable solvents or carbon tetrachloride for cleaning parts. Take safety precautions against toxic vapours of cleaning liquids.
- ⑤ Scrupulously observe cleanliness during maintenance and repair. Keep dirt away by covering the parts and exposed openings with a clean cloth, paper or tape.
- ⑥ Make sure that no tools, loose parts or rags are left in or on the unit.
- ⑦ Protect the electrical and regulating components, etc. to prevent moisture from entering these parts, e.g. when steam-cleaning.
- ⑧ Do not remove or tamper with the sound damping material in order to maintain the proper sound pressure level.

All responsibility for any damage or injury resulting from neglecting these precautions or by non-observance of ordinary caution and due care required in handling, operating, maintenance or repair, even if not expressly mentioned in this book, will be disclaimed by Denyo Co., LTD.

### По вопросам продаж и поддержки обращайтесь:

Архангельск (8182)63-90-72	Казань (843)206-01-48	Новокузнецк (3843)20-46-81	Смоленск (4812)29-41-54
Астана +7(7172)727-132	Калининград (4012)72-03-81	Новосибирск (383)227-86-73	Сочи (862)225-72-31
Астрахань (8512)99-46-04	Калуга (4842)92-23-67	Омск (3812)21-46-40	Ставрополь (8652)20-65-13
Барнаул (3852)73-04-60	Кемерово (3842)65-04-62	Орел (4862)44-53-42	Сургут (3462)77-98-35
Белгород (4722)40-23-64	Киров (8332)68-02-04	Оренбург (3532)37-68-04	Тверь (4822)63-31-35
Брянск (4832)59-03-52	Краснодар (861)203-40-90	Пенза (8412)22-31-16	Томск (3822)98-41-53
Владивосток (423)249-28-31	Красноярск (391)204-63-61	Пермь (342)205-81-47	Тула (4872)74-02-29
Волгоград (844)278-03-48	Курск (4712)77-13-04	Ростов-на-Дону (863)308-18-15	Тюмень (3452)66-21-18
Вологда (8172)26-41-59	Липецк (4742)52-20-81	Рязань (4912)46-61-64	Ульяновск (8422)24-23-59
Воронеж (473)204-51-73	Магнитогорск (3519)55-03-13	Самара (846)206-03-16	Уфа (347)229-48-12
Екатеринбург (343)384-55-89	Москва (495)268-04-70	Санкт-Петербург (812)309-46-40	Хабаровск (4212)92-98-04
Иваново (4932)77-34-06	Мурманск (8152)59-64-93	Саратов (845)249-38-78	Челябинск (351)202-03-61
Ижевск (3412)26-03-58	Набережные Челны (8552)20-53-41	Севастополь (8692)22-31-93	Череповец (8202)49-02-64
Иркутск (395) 279-98-46	Нижний Новгород (831)429-08-12	Симферополь (3652)67-13-56	Ярославль (4852)69-52-93
Киргизия (996)312-96-26-47	Казахстан (772)734-952-31	Таджикистан (992)427-82-92-69	